

DATA SHEET

Part No.	AN30235A
Package Code No.	UBGA036-W-3132AEL

Contents

■ Overview	3
■ Features	3
■ Applications	3
■ Package	3
■ Structure	3
■ Application Circuit Example	4
■ Block Diagram	5
■ Pin Layout	6
■ Pin Descriptions	7
■ Absolute Maximum Ratings	8
■ Operating Supply Voltage Range	8
■ Allowable Current and Voltage Ranges	9
■ Electrical Characteristics	10
■ Electrical Characteristics (Reference Values for Design)	13
■ Technical Data	16
1. Specifications of power supply block	16
2. Timing chart	17
3. I/O block circuit diagrams and pin function descriptions	24
4. P_D — T_a diagram	29
■ Usage Notes.....	30

AN30235A

2-Channel Step-up/down DC-DC Converter

■ Overview

AN30235A is a 2-channel step-up/down DC-DC converter with fixed switching frequency.

With one inductor for each channel, it can stably supply step-up/down voltages from two lithium-ion cells.

It has built-in N-channel MOSFET of low on resistance, allowing high efficient operation with fewer external components.

■ Features

- Wide range of input voltage (4.0 V to 8.4 V)
- 2-channel step-up/down DC-DC converter
 - DDCA: 4.5 V to 6.0 V / 850 mA
 - DDCB: 4.8 V / 1250 mA to 7.0 V / 800 mA
- High-accuracy feedback voltage ($\pm 2\%$)
- Synchronous rectifying system
- Bootstrap circuit
- Phase compensation
- Forced CCM (Continuous Conduction Mode)
- 1-MHz fixed switching frequency
- Digital soft start (5 ms)
- Shutdown function
- Short circuit protection with timer latch
- Power OK function

■ Applications

- Digital single lens reflex camera

■ Package

- 36-pin wafer level chip size package (WLCSP)
Size: 3.16 mm \times 3.06 mm (0.5 mm pitch)

■ Structure

- Bi-CMOS IC

■ Application Circuit Example

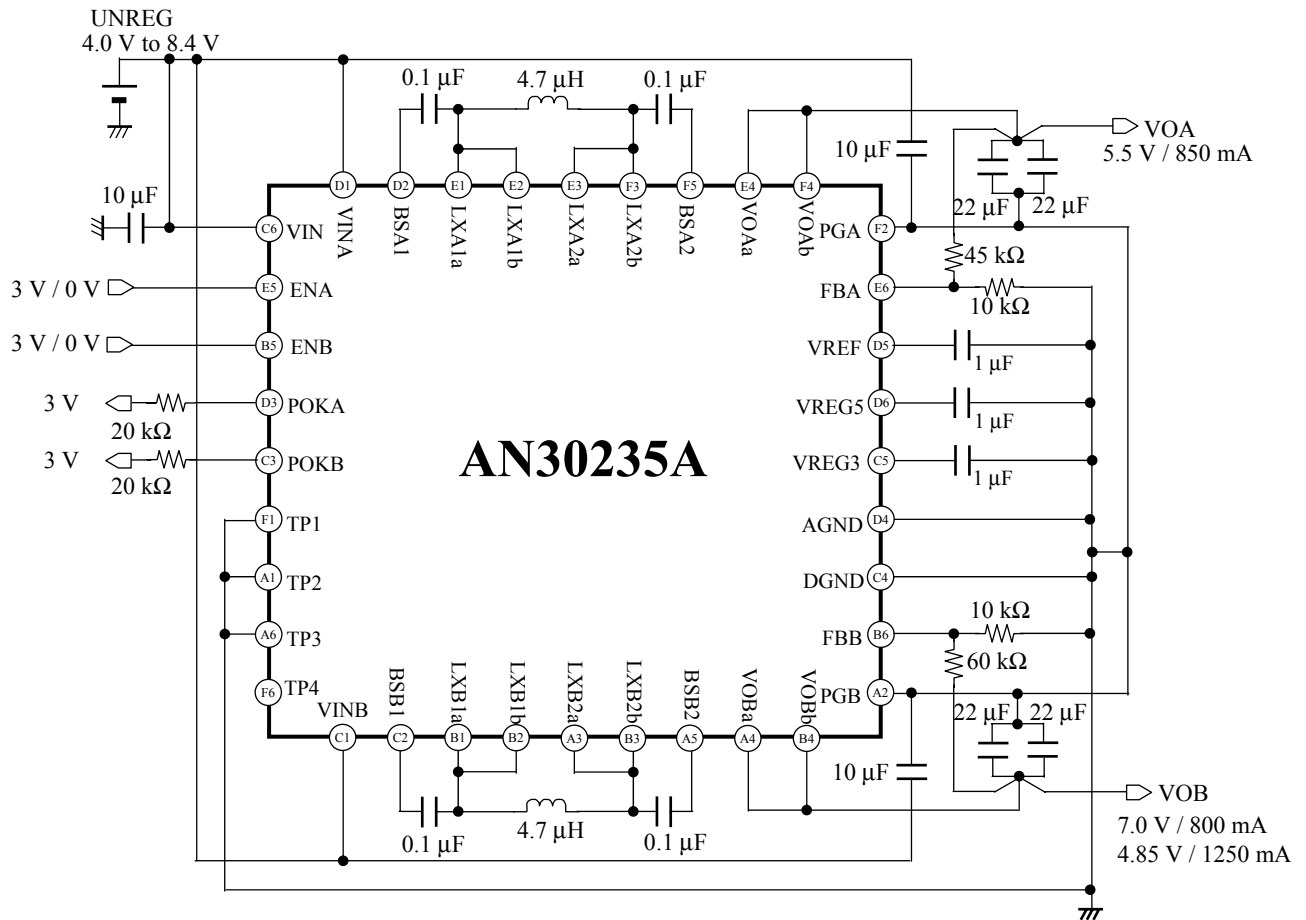

- Notes
- This application circuit is an example. Operation of mass production set is not guaranteed. Perform enough evaluation and verification on the design of mass production set.
 - In case of not using CHB block, set up following pins as mentioned below. Otherwise, failures like malfunction or others might occur.
 Left open: Pin A3 (LXB2a), Pin A5 (BSB2), Pin B1 (LXB1a), Pin B2 (LXB1b), Pin B3 (LXB2b), Pin C2 (BSB1) and Pin C3 (POKB)
 Connected to GND: Pin A4 (VOBa), Pin B4 (VOBb), Pin B5 (ENB) and Pin B6 (FBB)
 Connected to Pin C6 (VIN): Pin C1 (VINB)
 - In case of not using CHA block, set up following pins except Pin C3 (POKB), TBD, as mentioned below. Otherwise, failures like malfunction or others might occur.
 Left open: Pin D2 (BSA1), Pin E1 (LXA1a), Pin E2 (LXA1b), Pin E3 (LXA2a), Pin F3 (LXA2b), Pin F5 (BSA2) and Pin D3 (POKA)
 Connected to GND: Pin E4 (VOAa), Pin E5 (ENA), Pin E6 (FBA) and Pin F4 (VOAb)
 Connected to Pin C6 (VIN): Pin D1 (VINA)

■ Block Diagram

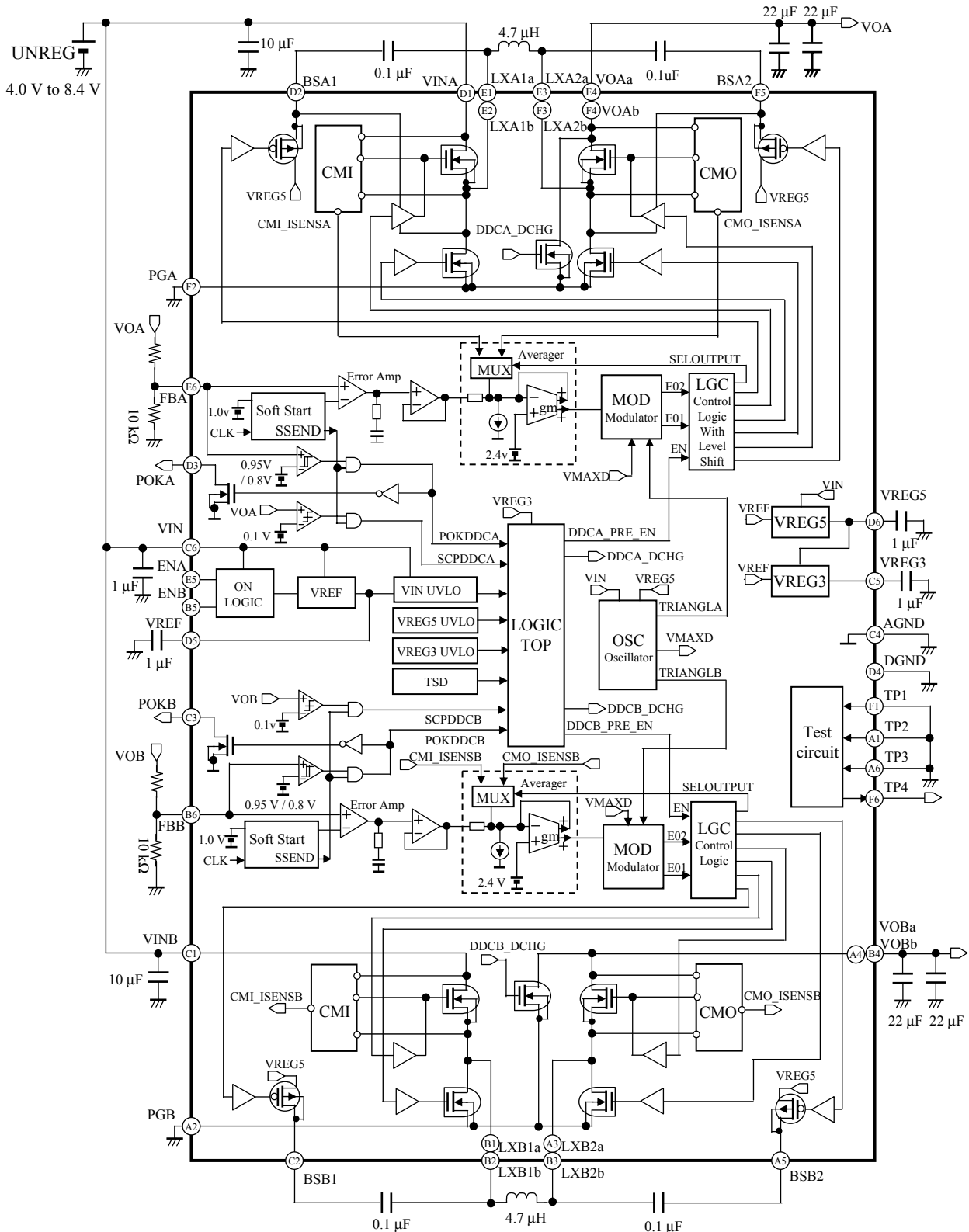

Note) This block diagram is for explaining functions. Some circuit blocks may be omitted, or simplified.

■ Pin Layout (Bottom View)

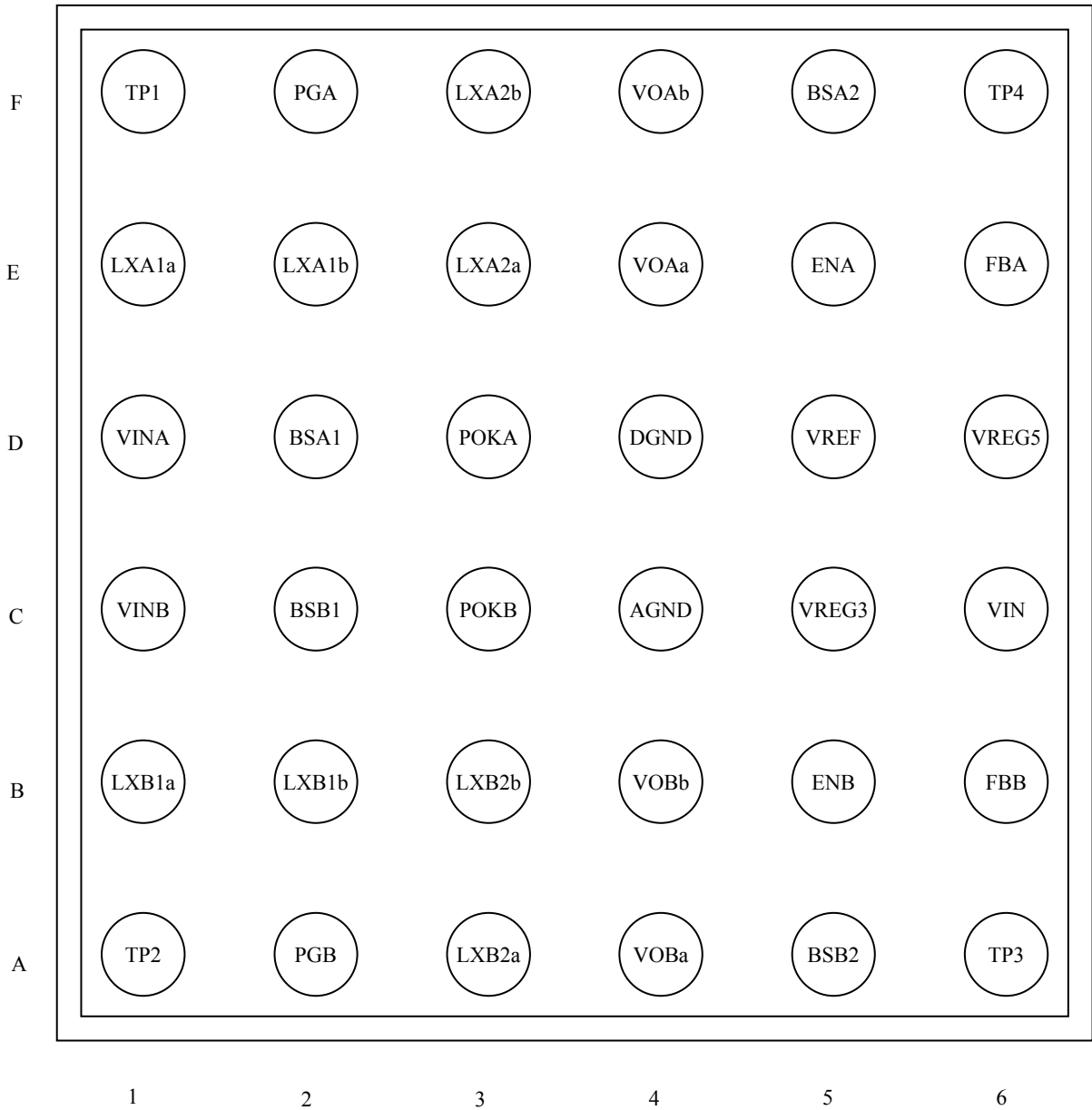

BOTTOM VIEW

- Notes) • Pin C1 (VINB) and Pin D1 (VINA) are connected via internal wiring.
 • Pin A2 (PGB) and Pin F2 (PGA) are connected via internal wiring.

■ Pin Descriptions

Pin No.	Pin Name	Type	Descriptions
A1	TP2	Input	Test circuit input
A2	PGB	Ground	PGND for channel-B
A3	LXB2a	Output	Coil connection for channel-B step-up
A4	VOBa	Output	Channel-B output
A5	BSB2	Input	Bootstrap for channel-B step-up
A6	TP3	Input	Test circuit input
B1	LXB1a	Output	Coil connection for channel-B step-down
B2	LXB1b	Output	Coil connection for channel-B step-down
B3	LXB2b	Output	Coil connection for channel-B step-up
B4	VOBb	Output	Channel-B output
B5	ENB	Input	Channel-B enable input
B6	FBB	Input	Feedback voltage input for channel-B
C1	VINB	Power Supply	Supply voltage input for channel-B
C2	BSB1	Input	Bootstrap for channel-B step-down
C3	POKB	Output	POK output for channel-B
C4	AGND	Ground	GND for analog circuit
C5	VREG3	Output	3.1-V regulator output
C6	VIN	Power Supply	Supply voltage input for internal circuits
D1	VINA	Power Supply	Supply voltage input for channel-A
D2	BSA1	Input	Bootstrap for channel-A step-down
D3	POKA	Output	POK output for channel-A
D4	DGND	Ground	GND for digital circuit
D5	VREF	Output	Reference voltage output
D6	VREG5	Output	5-V regulator output
E1	LXA1a	Output	Coil connection for channel-A step-down
E2	LXA1b	Output	Coil connection for channel-A step-down
E3	LXA2a	Output	Coil connection for channel-A step-up
E4	VOAa	Output	Channel-A output
E5	ENA	Input	Channel-A enable input
E6	FBA	Input	Feedback voltage input for channel-A
F1	TP1	Input	Test circuit input
F2	PGA	Ground	PGND for channel-A
F3	LXA2b	Output	Coil connection for channel-A step-up
F4	VOAb	Output	Channel-A output
F5	BSA2	Input	Bootstrap for channel-A step-up
F6	TP4	Output	Test circuit input

■ Absolute Maximum Ratings

Note) The absolute maximum ratings are the limit values beyond which the IC may be damaged. Operation is not guaranteed under these conditions.

A No.	Parameter	Symbol	Rating	Unit	Notes
1	Supply voltage	VIN, VINA, VINB	10	V	*1
2	Supply current	I _{CC}	—	A	—
3	Power dissipation	P _D	0.113	W	*2
4	Operating ambient temperature	T _{opr}	−20 to +85	°C	*3
5	Storage temperature	T _{stg}	−55 to +150	°C	*3

Notes) *1: The values are defined, provided that the IC is used within all of the above absolute maximum ratings including the power dissipation.

*2: The power dissipation shown is the value at T_a = 85°C for the independent (unmounted) IC package without a heat sink. When using this IC, refer to the P_D-T_a diagram of the package standard and design the heat radiation with sufficient margin not to exceed the allowable value based on the conditions of power supply voltage, load, and ambient temperature.

*3: All ratings are at T_a = 25°C, except the power dissipation, operating ambient temperature, and storage temperature.

■ Operating Supply Voltage Range

Parameter	Symbol	Range	Unit	Note
Supply voltage range	VIN, VINA, VINB	4.0 to 8.4	V	*1

Note) *1: The value is defined, provided that the IC is used within all of the above absolute maximum ratings including the power dissipation.

■ Allowable Current and Voltage Ranges

Notes) • The allowable current and voltage ranges are limit values beyond which the IC may be damaged. Operation is not guaranteed under these conditions.

• Rating voltages are voltages on each pin, with respect to the GND. GND denotes the voltage of AGND, DGND, PGB and PGA.

(GND = AGND = DGND = PGA = PGB)

• Do not apply external current or voltages to any pins except mentioned below.

Pin No.	Pin Name	Rating Voltage	Unit	Notes	Pin No.	Pin Name	Rating Voltage	Unit	Notes
E5 B5	ENA ENB	- 0.3 to 3.6	V	—	E4 F4	VOAa VOAb	- 0.3 to 10	V	*2
E6 B6	FBA FBB	- 0.3 to 3.3	V	—	A4 B4	VOBa VOBb	- 0.3 to 10	V	*2
D3 C3	POKA POKB	- 0.3 to 3.6	V	—	E1 E2	LXA1a LXA1b	- 0.3 to (VINA + 0.3)	V	*1 *2
D2	BSA1	- 0.3 to (VINA + VREG5 + 0.3)	V	—	E3 F3	LXA2a LXA2b	- 0.3 to (VOA + 0.3)	V	*1 *2
F5	BSA2	- 0.3 to (VOA + VREG5 + 0.3)	V	—	B1 B2	LXB1a LXB1b	- 0.3 to (VINB + 0.3)	V	*1 *2
C2	BSB1	- 0.3 to (VINB + VREG5 + 0.3)	V	—	A3 B3	LXB2a LXB2b	- 0.3 to (VOB + 0.3)	V	*1 *2
A5	BSB2	- 0.3 to (VOB + VREG5 + 0.3)	V	—					

Notes) *1: Do not exceed 10 V for specified voltage.

*2: Applying external voltage into these pins is prohibited, because they are output pins.

■ Electrical Characteristics

Note) $T_a = 25^\circ\text{C} \pm 2^\circ\text{C}$, unless otherwise specified.

B No.	Parameter	Symbol	Conditions	Limits			Unit	Notes
				Min	Typ	Max		
Consumption Current Characteristics VIN = 8.4 V								
A1	Shutdown consumption current	ISHDN	ENA = ENB = 0 V	—	—	5	μA	—
UVLO Characteristics								
B1	VIN_UVLO detection voltage	VUUVL	—	3.0	3.30	—	V	—
B2	VIN_UVLO release voltage	VUUVLN	—	—	3.50	3.85	V	—
B3	VIN_UVLO hysteresis voltage	VHYSU	—	0.15	0.20	—	V	—
B4	VREG5_UVLO detection voltage	VR5UVL	—	3.0	3.3	—	V	—
B5	VREG5_UVLO release voltage	VR5UVLN	—	—	3.5	3.85	V	—
B6	VREG5_UVLO hysteresis voltage	VHYSR5	—	0.15	0.20	—	V	—
B7	VREG3_UVLO detection voltage	VR3UVL	—	2.30	2.55	—	V	—
B8	VREG3_UVLO release voltage	VR3UVLN	—	—	2.75	3.0	V	—
B9	VREG3_UVLO hysteresis voltage	VHYSR3	—	0.08	0.2	—	V	—
Enable Characteristics (ENA, ENB) VIN = 7.4 V								
C1	Input voltage (High)	VIH	—	2.2	—	3.3	V	—
C2	Input voltage (Low)	VIL	—	0	—	0.4	V	—
C3	Pull-down resistance	RPDWN	—	400	—	—	kΩ	—
REF Characteristics (Reference Voltage) VIN = 7.4 V, Input Capacitance: 1.0 μF (Rank-B), Output Capacitance: 1.0 μF (Rank-B)								
D1	VREF pin voltage	VREF	DDCA, B switching OFF	1.224	1.236	1.248	V	—
VREG Characteristics (Linear Power Supply) VIN = 7.4 V, Output Capacitance: 1.0 μF (Rank-B)								
E1	VREG5 output voltage	VREG5	No load	4.7	5.0	5.3	V	—
E2	VREG3 output voltage	VREG3	No load	2.95	3.1	3.25	V	—

■ Electrical Characteristics (continued)

Note) $T_a = 25^\circ\text{C} \pm 2^\circ\text{C}$, unless otherwise specified.

For the circuit current I_{out} , “+” denotes current flowing into the IC, and “-” denotes current flowing out from the IC.

B No.	Parameter	Symbol	Conditions	Limits			Unit	Notes
				Min	Typ	Max		
DDCA Characteristics (Synchronous Rectification / Step-up/down / Fixed Frequency / Current Mode / DC-DC Converter)								
Input Voltage: $V_{INA} = 7.4\text{ V}$, Output Voltage: $V_{out} = 5.5\text{ V}$, $ENB = 0\text{ V}$ (Unless otherwise specified)								
Input Capacitance: $10\text{ }\mu\text{F}$, Output Capacitance: $44\text{ }\mu\text{F}$ (Effective value: at least $22\text{ }\mu\text{F}$)								
Choke Coil: NR6020T4R7M, $L = 4.7\text{ }\mu\text{H}$								
F1	Consumption current A0	ICCA	$V_{IN} = 8.4\text{ V}$, no-load output $EN_A = 3.3\text{ V}$, $EN_B = 0\text{ V}$ $I_{outA} = 0\text{ A}$, $V_{outA} = 5.5\text{ V}$	—	10	15	mA	—
F2	Output voltage A1	VODDCA1	$V_{INA} = 4.0\text{ V}$, 8.4 V $I_{out} = -1\text{ mA}$	5.417	5.5	5.583	V	—
F3	Output voltage A2	VODDCA2	$V_{INA} = 4.0\text{ V}$ $I_{out} = -220\text{ mA}$	5.417	5.5	5.583	V	—
F4	Output voltage A3	VODDCA3	$V_{INA} = 8.4\text{ V}$ $I_{out} = -850\text{ mA}$	5.417	5.5	5.583	V	—
F5	Soft start time 1	SSDDCA1	$V_{INA} = 4.0\text{ V}$ $V_{out} = 5.5\text{ V}$, $I_{out} = -1\text{ mA}$	3.6	4.6	5.6	ms	—
F6	Soft start time 2	SSDDCA2	$V_{INA} = 8.4\text{ V}$ $V_{out} = 5.5\text{ V}$, $I_{out} = -1\text{ mA}$	3.6	4.6	5.6	ms	—
F10	POK detection voltage	VTHDPOKA	—	75	80	85	%	—
F11	POK release voltage	VTHRPOKA	—	91	95	99	%	—
F12	SCP detection delay time	SCDELDDCA	—	70	100	130	ms	—
F13	Rapid SCP detection voltage	VRSCDDCB	—	50	100	150	mV	—
F14	On resistance of discharge switch	RDCDDCA	—	—	—	100	Ω	—
F15	On resistance of high-side input switch	RONH1DDCA	$V_{INA} = 7.4\text{ V}$	—	0.125	0.18	Ω	—
F16	On resistance of low-side input switch	RONL1DDCA	—	—	0.14	0.20	Ω	—
F17	On resistance of high-side output switch	RONH2DDCA	$V_{out} = 5.5\text{ V}$	—	0.125	0.18	Ω	—
F18	On resistance of low-side output switch	RONL2DDCA	—	—	0.14	0.20	Ω	—
F19	Switching frequency 0	FSDDCA	$V_{INA} = 4.0\text{ V}$ to 8.4 V	0.8	1	1.2	MHz	*1
F20	Load regulation	REGINDDCA	$V_{INA} = 4.0\text{ V}$, 8.4 V $\Delta V_{out} = V_{out}(-1\text{ mA}) - V_{out}(-220, -850\text{ mA}) $	—	—	82.5	mV	—
F21	Line regulation	REGLDDCA	$I_{out} = -1\text{ mA}$ $\Delta V_{out} = V_{out}(V_{INA} = 4.0\text{ V}) - V_{out}(V_{INA} = 8.4\text{ V}) $	—	—	82.5	mV	—
F22	On resistance of POKA pin	RONPOKA	—	—	—	1.0	$\text{k}\Omega$	—

Note) *1: This indicates the characteristics in test mode.

■ Electrical Characteristics (continued)

Note) $T_a = 25^\circ\text{C} \pm 2^\circ\text{C}$, unless otherwise specified.

For the circuit current I_{out} , “+” denotes current flowing into the IC, and “-” denotes current flowing out from the IC.

B No.	Parameter	Symbol	Conditions	Limits			Unit	Notes
				Min	Typ	Max		
DDCB Characteristics (Synchronous Rectification / Step-up/down / Fixed Frequency / Current Mode / DC-DC Converter) Input Voltage: $V_{INB} = 7.4\text{ V}$, Output Voltage: $V_{out} = 7.0\text{ V}$, $E_{NA} = 0\text{ V}$ (Unless otherwise specified) Input Capacitance: $10\text{ }\mu\text{F}$, Output Capacitance: $44\text{ }\mu\text{F}$ (Effective value: at least $22\text{ }\mu\text{F}$) Choke Coil: NR6020T4R7M, $L = 4.7\text{ }\mu\text{H}$								
G1	Consumption current B0	ICCB	$V_{IN} = 8.4\text{ V}$, no-load output $E_{NA} = 0\text{ V}$, $E_{NB} = 3.3\text{ V}$ $I_{outB} = 0\text{ A}$, $V_{outB} = 7.0\text{ V}$	—	10	15	mA	—
G2	Output voltage B1	VODDCB1	$V_{INB} = 4.0\text{ V}$, 8.4 V $I_{out} = -1\text{ mA}$	6.895	7.0	7.105	V	—
G3	Output voltage B2	VODDCB2	$V_{INB} = 4.0\text{ V}$ $I_{out} = -160\text{ mA}$	6.895	7.0	7.105	V	—
G4	Output voltage B3	VODDCB4	$V_{INB} = 8.4\text{ V}$ $I_{out} = -800\text{ mA}$	6.895	7.0	7.105	V	—
G5	Soft start time 1	SSDDCB1	$V_{INB} = 4.0\text{ V}$ $V_{out} = 5.5\text{ V}$, $I_{out} = -1\text{ mA}$	3.6	4.6	5.6	ms	—
G6	Soft start time 2	SSDDCB2	$V_{INB} = 8.4\text{ V}$ $V_{out} = 5.5\text{ V}$, $I_{out} = -1\text{ mA}$	3.6	4.6	5.6	ms	—
G10	POK detection voltage	VTHDPOKB	—	75	80	85	%	—
G11	POK release voltage	VTHRPOKB	—	91	95	99	%	—
G12	SCP detection delay time	SCDELDDCA	—	70	100	130	ms	—
G13	Rapid SCP detection voltage	VRSCDDCB	—	50	100	150	mV	—
G14	On resistance of discharge switch	RDCDD2P9	—	—	—	100	Ω	—
G15	On resistance of high-side input switch	RONH1DDCB	$V_{INB} = 7.4\text{ V}$	—	0.10	0.14	Ω	—
G16	On resistance of low-side input switch	RONL1DDCB	—	—	0.14	0.20	Ω	—
G17	On resistance of high-side output switch	RONH2DDCB	$V_{out} = 7.0\text{ V}$	—	0.10	0.14	Ω	—
G18	On resistance of low-side output switch	RONL2DDCB	—	—	0.14	0.20	Ω	—
G19	switching frequency 0	FSDDCB	$V_{INB} = 4.0\text{ V}$ to 8.4 V	0.8	1	1.2	MHz	*1
G20	Load regulation	REGINDDCB	$V_{INB} = 4.0\text{ V}$, 8.4 V $\Delta V_{out} = V_{out}(-1\text{ mA}) - V_{out}(-160, -800\text{ mA}) $	—	—	105	mV	—
G21	Line regulation	REGLDDCB	$I_{out} = -1\text{ mA}$ $\Delta V_{out} = V_{out}(V_{INB} = 4.0\text{ V}) - V_{out}(V_{INB} = 8.4\text{ V}) $	—	—	105	mV	—
G22	On resistance of POKB pin	RONPOKB	—	—	—	1.0	k Ω	—

Note) *1: This indicates the characteristics in test mode.

■ Electrical Characteristics (Reference Values for Design)

Note) $T_a = 25^\circ\text{C} \pm 2^\circ\text{C}$, unless otherwise specified.

For the circuit current I_{out} , “+” denotes current flowing into the IC, and “-” denotes current flowing out from the IC.

If, by any chance, the problem caused by these characteristics occurs, we will respond in good faith to user concerns.

B No.	Parameter	Symbol	Conditions	Limits			Unit	Notes
				Min	Typ	Max		
Enable Characteristics (ENA, ENB) $V_{IN} = 7.4 \text{ V}$								
c1	Hysteresis voltage	VHYS	—	—	0.2	—	V	—
REF Characteristics (Reference Voltage) $V_{IN} = 7.4 \text{ V}$, Input Capacitance: $1.0 \mu\text{F}$ (Rank-B), Output Capacitance: $1.0 \mu\text{F}$ (Rank-B)								
d1	VREF pin voltage	VREF	$T_a = -20^\circ\text{C}$ to 85°C $V_{in} = 1.8 \text{ V}$ to 5.41 V $I_{out} = 0 \mu\text{A}$	1.218	1.236	1.254	V	—
TSD Characteristics (Reference Voltage) $V_{IN} = 7.4 \text{ V}$								
h1	TSD detection temperature	TSD	—	150	170	—	$^\circ\text{C}$	—

■ Electrical Characteristics (Reference Values for Design) (continued)

Note) $T_a = 25^\circ\text{C} \pm 2^\circ\text{C}$, unless otherwise specified.

For the circuit current I_{out} , “+” denotes current flowing into the IC, and “-” denotes current flowing out from the IC.

If, by any chance, the problem caused by these characteristics occurs, we will respond in good faith to user concerns.

B No.	Parameter	Symbol	Conditions	Limits			Unit	Notes
				Min	Typ	Max		
DDCA Characteristics (Synchronous Rectification / Step-up/down / Fixed Frequency / Current Mode / DC-DC Converter) Input Voltage: $V_{INA} = 7.4\text{ V}$, Output Voltage: $V_{out} = 5.5\text{ V}$ (Unless otherwise specified) Input Capacitance: $10\ \mu\text{F}$, Output Capacitance: $44\ \mu\text{F}$ (Effective value: at least $22\ \mu\text{F}$) Choke Coil: NR6020T4R7M, $L = 4.7\ \mu\text{H}$								
f1	FBA pin voltage	VFBA	$T_a = -20^\circ\text{C}$ to 85°C , $V_{INA} = 4.0\text{ V}$ to 8.4 V	0.98	1.0	1.02	V	—
f2	Input bias current of FBA pin	IFBA	—	—	-10	—	nA	—
f3	Setting range of output voltage	VOUTA	—	4.5	—	6.0	V	—
f4	Output voltage	VOA	$T_a = -20^\circ\text{C}$ to 85°C , $V_{INA} = 4.0\text{ V}$ to 8.4 V $I_{out} = -1\text{ mA}$ to -850 mA The dispersion of external resistance connected to FBA pin is ignored.	5.39	5.50	5.61	V	—
f5	Output ripple voltage	VOAR	$V_{INA} = 4.0\text{ V}$, 8.4 V $I_{out} = -1\text{ mA}$ to -850 mA $\text{ESR}(\text{Co}) = 2.5\text{ m}\Omega$	—	25	—	mV	—
f6	Switching frequency	FSA	$V_{INA} = 4.0\text{ V}$ to 8.4 V	0.75	1	1.25	MHz	—
f7	Maximum duty cycle of step-up	DMAXA	$V_{INA} = 4.0\text{ V}$ to 8.4 V	65	80	95	%	—

■ Electrical Characteristics (Reference Values for Design) (continued)

Note) $T_a = 25^\circ\text{C} \pm 2^\circ\text{C}$, unless otherwise specified.

For the circuit current I_{out} , “+” denotes current flowing into the IC, and “-” denotes current flowing out from the IC.

If, by any chance, the problem caused by these characteristics occurs, we will respond in good faith to user concerns.

B No.	Parameter	Symbol	Conditions	Limits			Unit	Notes
				Min	Typ	Max		
DDCB Characteristics (Synchronous Rectification / Step-up/down / Fixed Frequency / Current Mode / DCDC Converter) Input Voltage: $V_{INB} = 7.4\text{ V}$, Output Voltage: $V_{out} = 7.0\text{ V}$ (Unless otherwise specified) Input Capacitance: $10\ \mu\text{F}$, Output Capacitance: $44\ \mu\text{F}$ (Effective value: at least $22\ \mu\text{F}$) Choke Coil: NR6020T4R7M, $L = 4.7\ \mu\text{H}$								
g1	FBB pin voltage	VFBB	$T_a = -20^\circ\text{C}$ to 85°C , $V_{INB} = 4.0\text{ V}$ to 8.4 V	0.98	1.0	1.02	V	—
g2	Input bias current of FBB pin	IFBB	—	—	-10	—	nA	—
g3	Setting range of output voltage	VOUTB	—	4.8	—	7.0	V	—
g4	Output voltage 1	VOB1	$T_a = -20^\circ\text{C}$ to 85°C , $V_{INB} = 4.0\text{ V}$ to 8.4 V Output voltage: $V_{out} = 7.0\text{ V}$ $I_{out} = -1\text{ mA}$ to -800 mA The dispersion of external resistance connected to FBB pin is ignored.	6.86	7.0	7.14	V	—
g5	Output voltage 2	VOB2	$T_a = -20^\circ\text{C}$ to 85°C , $V_{INB} = 4.0\text{ V}$ to 8.4 V Output voltage: $V_{out} = 4.85\text{ V}$ $I_{out} = -1\text{ mA}$ to -1250 mA The dispersion of external resistance connected to FBB pin is ignored.	4.753	4.85	4.947	V	—
g6	Output ripple voltage 1	VOBR1	$V_{INB} = 4.0\text{ V}, 8.4\text{ V}$ Output voltage: $V_{out} = 7.0\text{ V}$ $I_{out} = -1\text{ mA}$ to -800 mA $\text{ESR}(C_o) = 2.5\text{ m}\Omega$	—	30	—	mV	—
g7	Output ripple voltage 2	VOBR2	$V_{INB} = 4.0\text{ V}, 8.4\text{ V}$ Output voltage: $V_{out} = 4.85\text{ V}$ $I_{out} = -1\text{ mA}$ to -1250 mA $\text{ESR}(C_o) = 2.5\text{ m}\Omega$	—	45	—	mV	—
g8	Switching frequency	FSB	$V_{INB} = 4.0\text{ V}$ to 8.4 V	0.75	1	1.25	MHz	—
g9	Maximum duty cycle of step-up	DMAXB	$V_{INB} = 4.0\text{ V}$ to 8.4 V	65	80	95	%	—

■ Technical Data

1. Specifications of Power Supply Block

- Specifications of DC-DC converter

Name	Control				Input Voltage (V)		Output Voltage (V)		POK	OVP	SCP	Load Switch	Discharge Switch
	Type	Synchronous Rectification	Mode	System	Min	Max	Min	Max					
DDCA	Step-up/down	Yes	Average current	Fixed frequency	4.0	8.4	4.5	6.0	Yes	—	Yes	—	Yes
DDCB	Step-up/down	Yes	Average current	Fixed frequency	4.0	8.4	4.8	7.0	Yes	—	Yes	—	Yes

■ Technical Data (continued)

2. Timing Chart

Note) These characteristics are reference values for design, and are not guaranteed.

- UNREG_IN → ENABLE → START (DDCB: Disable)

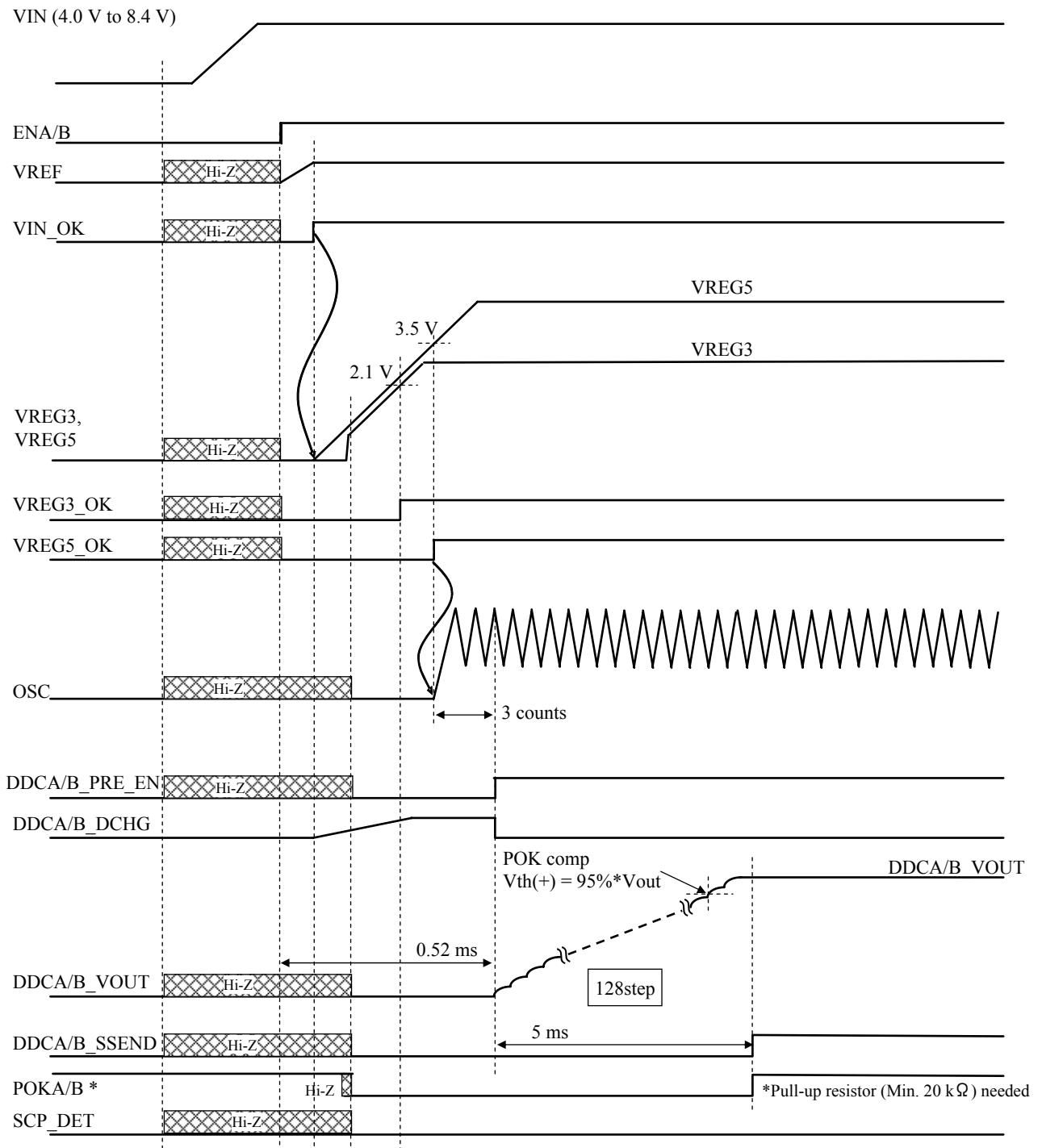

■ Technical Data (continued)

2. Timing Chart (continued)

Note) These characteristics are reference values for design, and are not guaranteed.

- UNREG_IN → ENABLE-START (OUTPUT-GND short / DDCB: Disable)

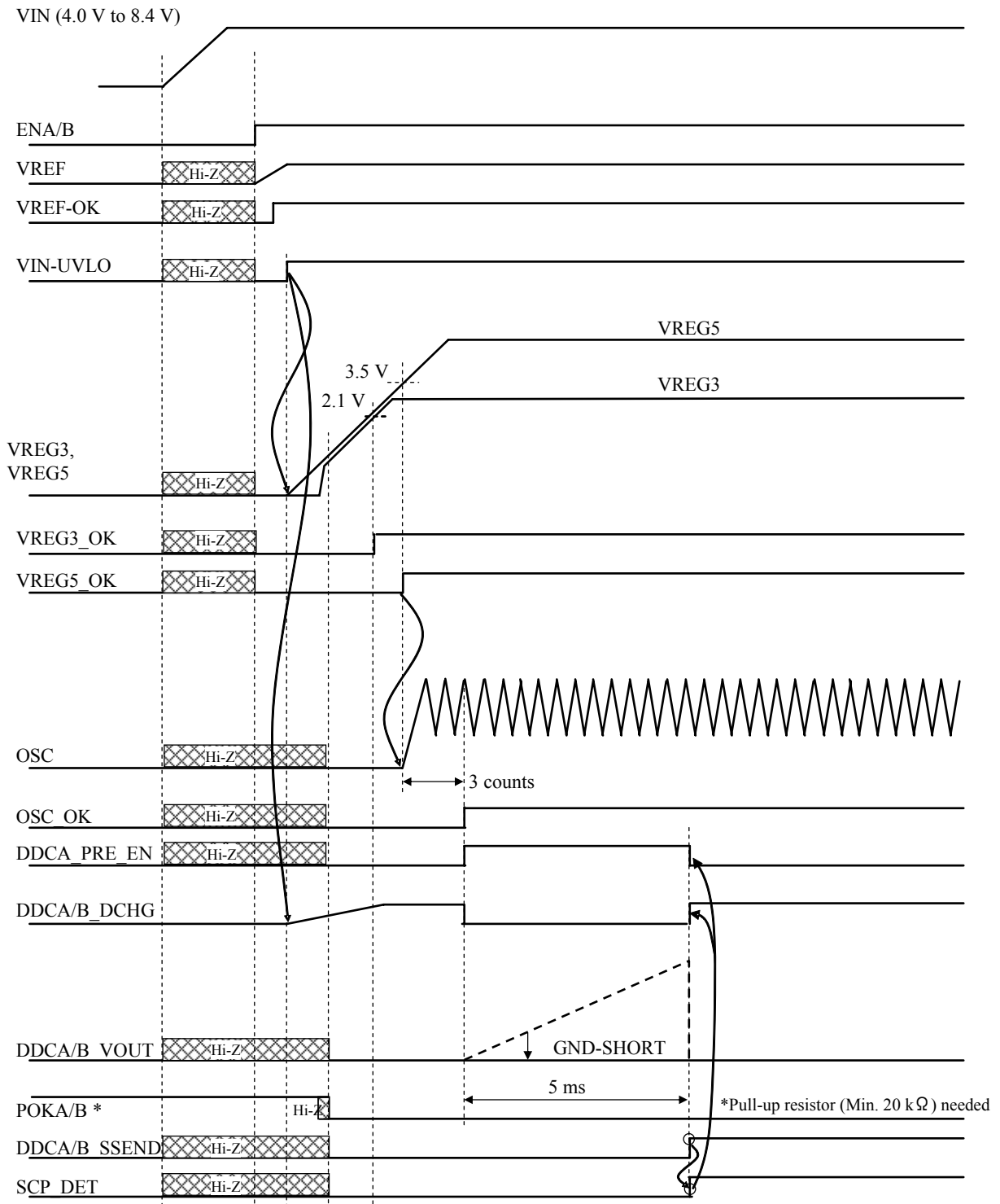

■ Technical Data (continued)

2. Timing Chart (continued)

Note) These characteristics are reference values for design, and are not guaranteed.

- ENABLE → STOP (DDCB: Disable)

VIN (4.0 V to 8.4 V)

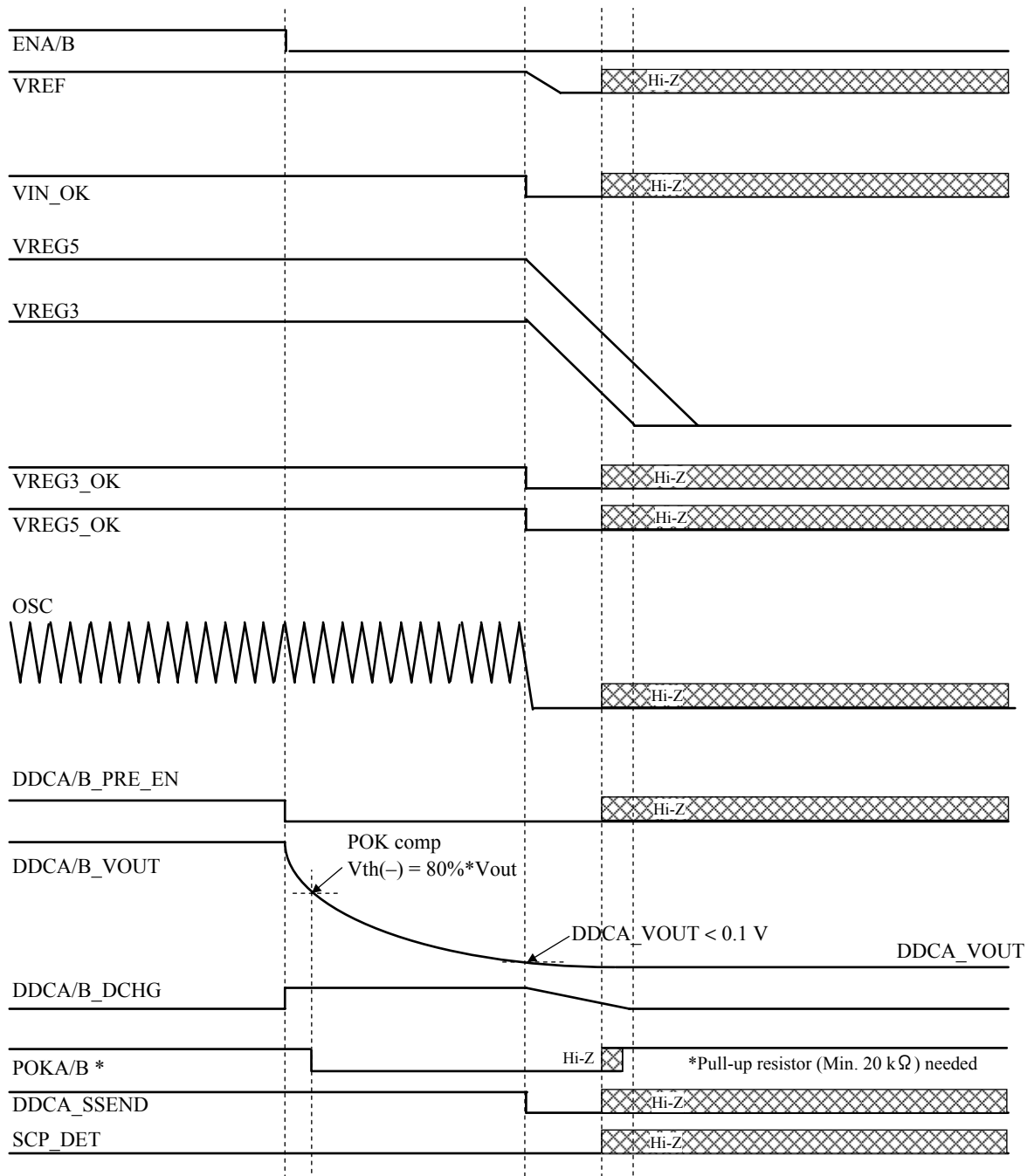

■ Technical Data (continued)

2. Timing Chart (continued)

Note) These characteristics are reference values for design, and are not guaranteed.

- SCPDET → STOP → ENA "H" → "L" (DDCB: Disable)

VIN (4.0 V to 8.4 V)

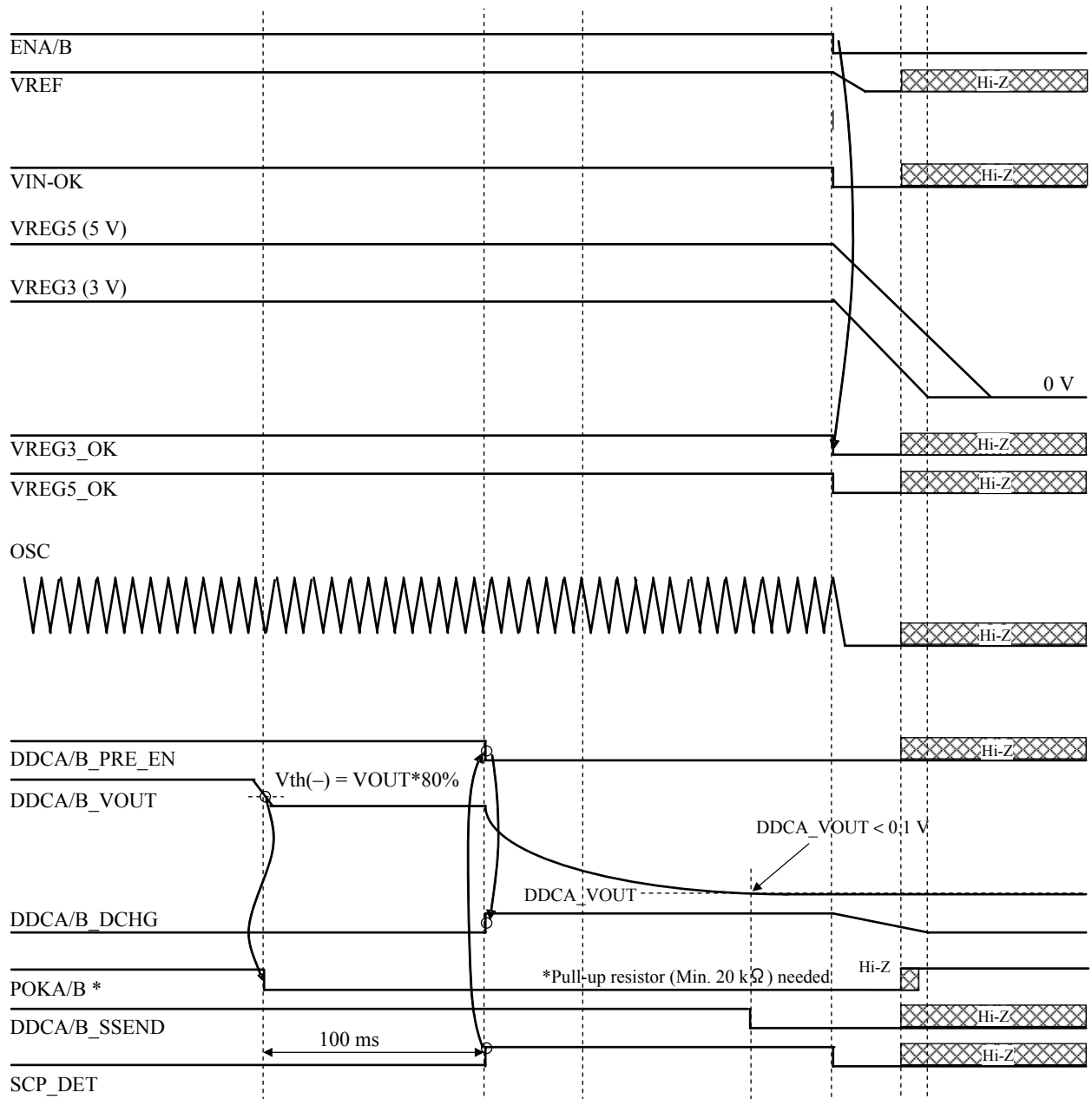

■ Technical Data (continued)

2. Timing Chart (continued)

Note) These characteristics are reference values for design, and are not guaranteed.

- SCPDET (OUTPUT-GND short) → STOP → ENA "H" → "L" (DDCB: Disable)

VIN (4.0 V to 8.4 V)

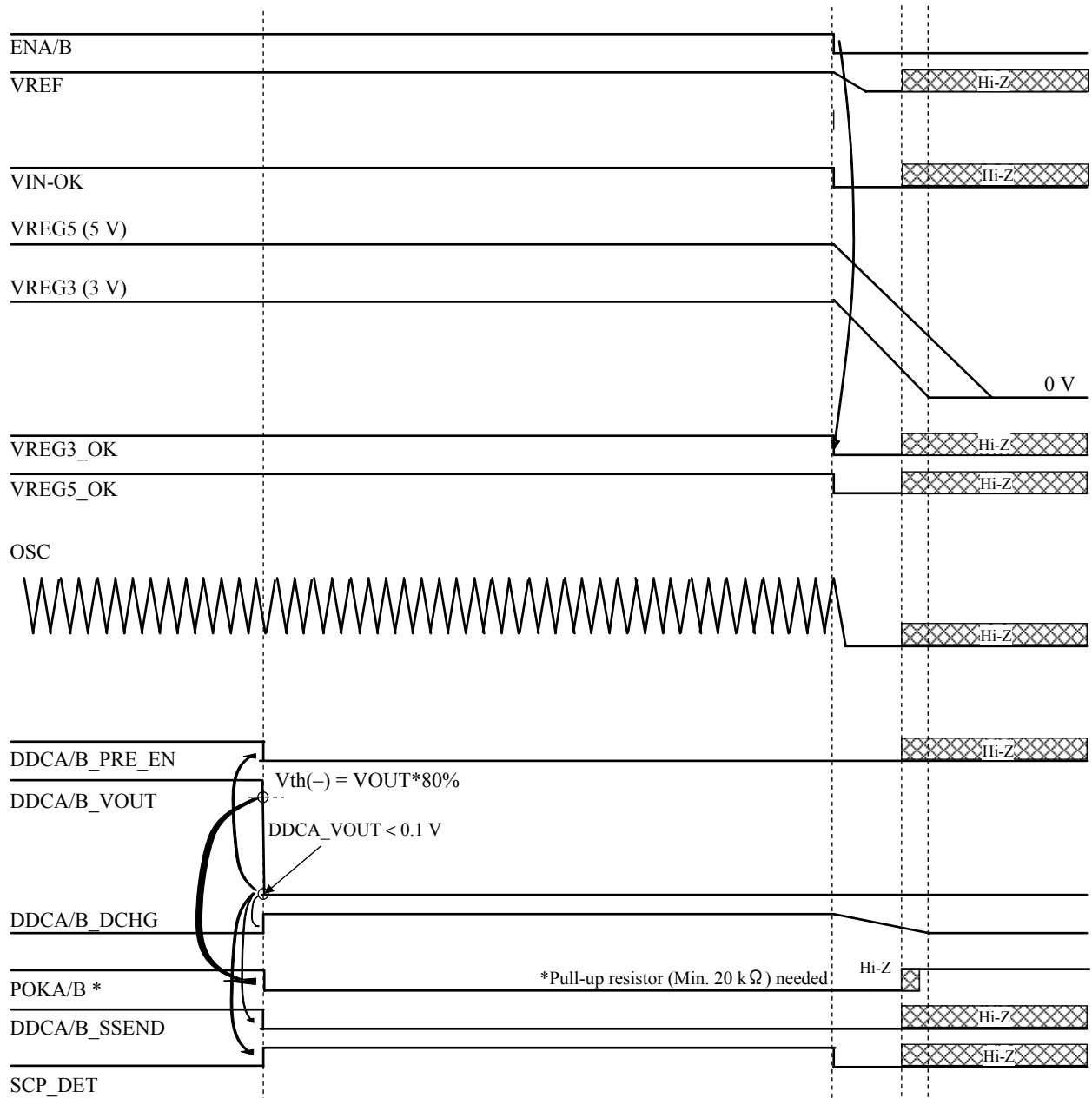

■ Technical Data (continued)
 2. Timing Chart (continued)

Note) These characteristics are reference values for design, and are not guaranteed.

- VIN = 8.4 V → VIN = 3.0 V → VIN = 8.4 V (DDCB: Disable)

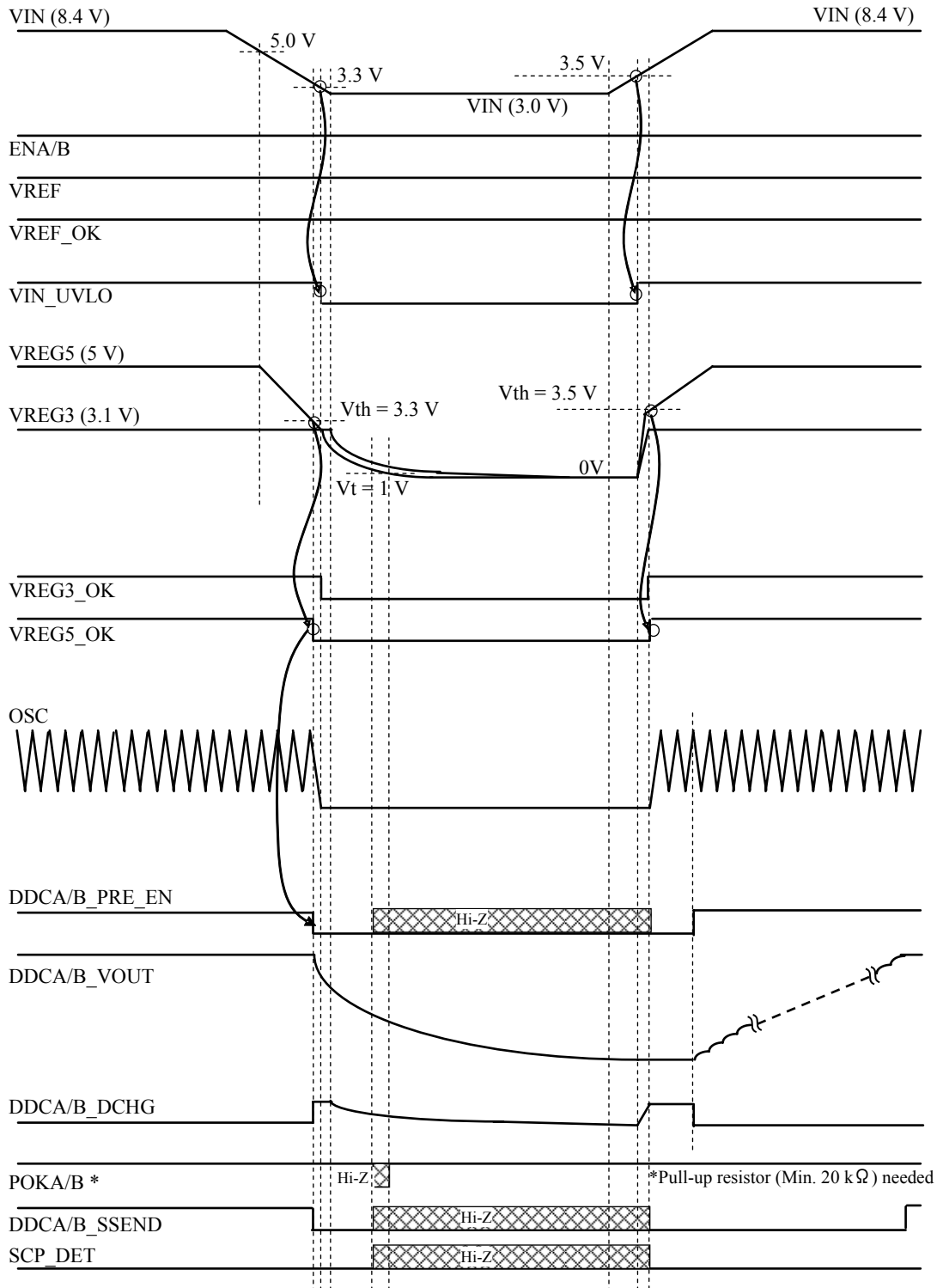

■ Technical Data (continued)
 2. Timing Chart (continued)

Note) These characteristics are reference values for design, and are not guaranteed.

- ENA "H" → TSD-DETECT → ENA "L" (DDCB: Disable)

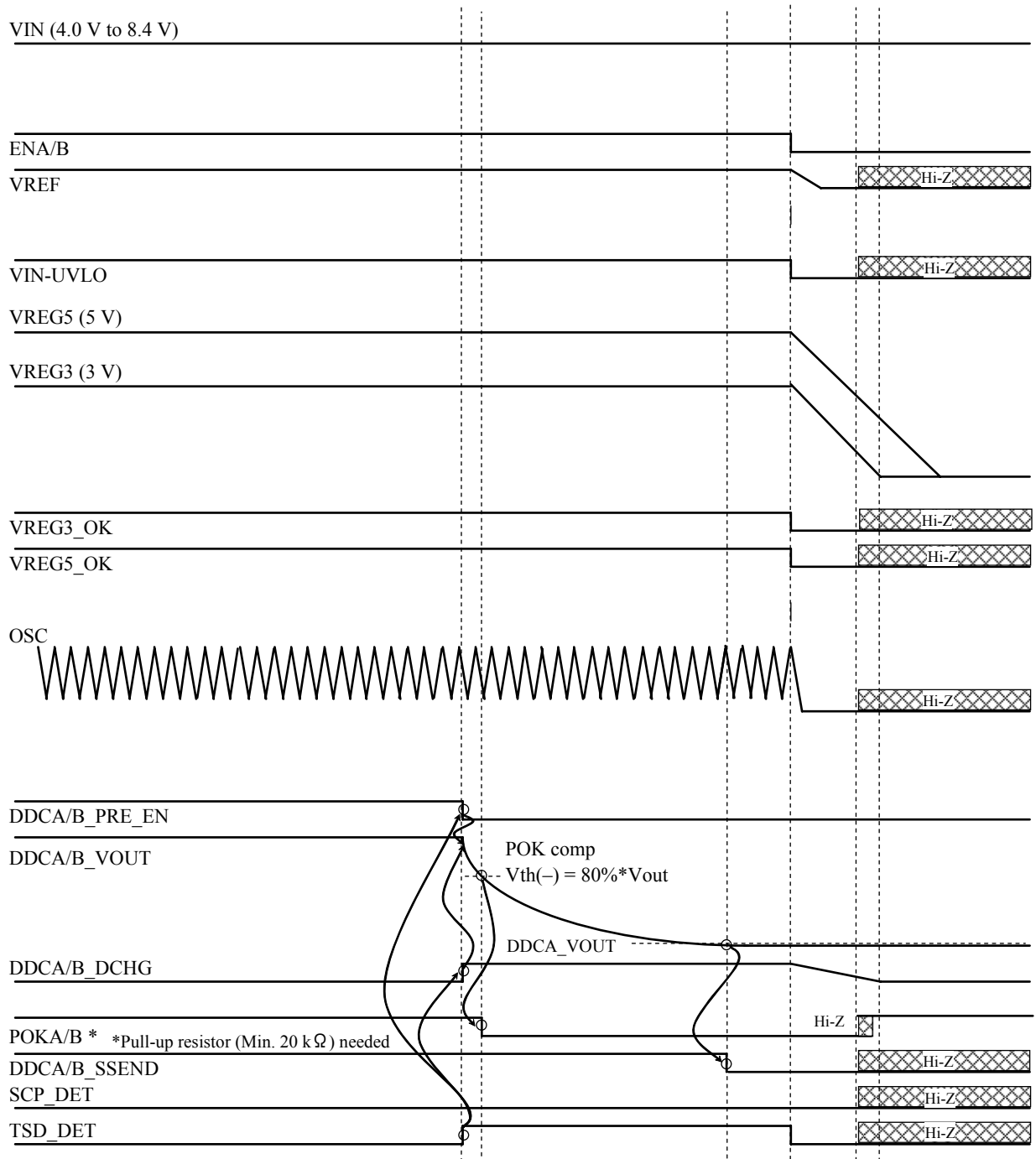

■ Technical Data (continued)

3. I/O Block Circuit Diagrams and Pin Function Descriptions

Note) These characteristics are reference values for design, and are not guaranteed.

Pin No.	Waveform and Voltage	Internal Circuit	Impedance	Descriptions
E1	<p>VINA 0 V</p>	<p>VINA E1 E2 PGA</p>	—	LXA1a Coil connection for channel-A step-down
E2				LXA1b Coil connection for channel-A step-down
E3	<p>VOA 0 V</p>	<p>VOA E3 F3 PGA</p>	—	LXA2a Coil connection for channel-A step-up
F3				LXA2b Coil connection for channel-A step-up
E4	<p>DC 4.5 V to 6.0 V</p>	<p>E4 F4 LXA2 AGND PGA</p>	—	VOAa Channel-A output
F4				VOAb Channel-A output
D2	<p>VINA+VREG5 0 V</p>	<p>VINA D2 VREG5 Pin E1, E2 LXA1a, LXA1b PGA</p>	—	BSA1 Bootstrap for channel-A step-down
F5	<p>VOA+VREG5 0 V</p>	<p>VOA F5 VREG5 Pin E3, F3 LXA2a, LXA2b PGA</p>	—	BSA2 Bootstrap for channel-A step-up

■ Technical Data (continued)

3. I/O Block Circuit Diagrams and Pin Function Descriptions (continued)

Note) These characteristics are reference values for design, and are not guaranteed.

Pin No.	Waveform and Voltage	Internal Circuit	Impedance	Descriptions
B1			—	LXB1a Coil connection for channel-B step-down
B2				LXB1b Coil connection for channel-B step-down
A3			—	LXB2a Coil connection for channel-B step-up
B3				LXB2b Coil connection for channel-B step-up
A4	DC 4.8 V to 7.0 V		—	VOBa Channel-B output
B4				VOBb Channel-B output
C2			—	BSB1 Bootstrap for channel-B step-down
A5			—	BSB2 Bootstrap for channel-B step-up

■ Technical Data (continued)

3. I/O Block Circuit Diagrams and Pin Function Descriptions (continued)

Note) These characteristics are reference values for design, and are not guaranteed.

Pin No.	Waveform and Voltage	Internal Circuit	Impedance	Descriptions
C4	GND		—	AGND GND for analog circuit
D4	GND		—	DGND GND for digital circuit
A2	GND		—	PGB PGND for Channel-B
F2				PGA PGND for Channel-A
D1	DC 4.0 V to 8.4 V		—	VINA Supply voltage input for channel-A
C1	DC 4.0 V to 8.4 V		—	VINB Supply voltage input for channel-B
C6	DC 4.0 V to 8.4 V		—	VIN Supply voltage input for internal circuit
D3	External voltage (Pull-up) 0 V		—	POKA POK output for channel-A
C3	External voltage (Pull-up) 0 V		—	POKB POK output for channel-B

■ Technical Data (continued)

3. I/O Block Circuit Diagrams and Pin Function Descriptions (continued)

Note) These characteristics are reference values for design, and are not guaranteed.

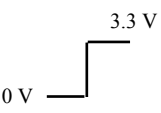
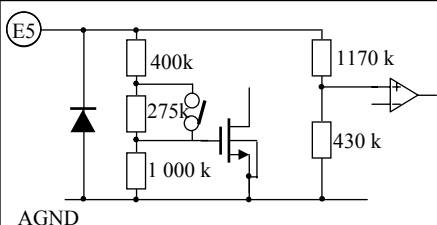
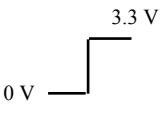
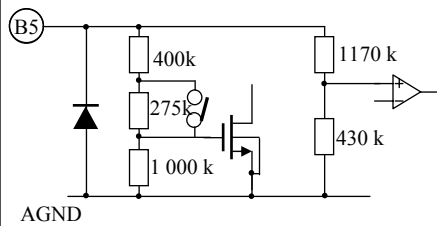
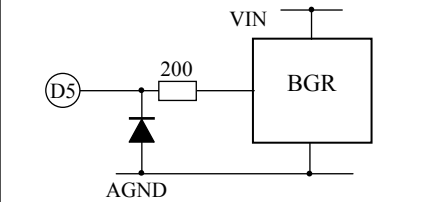
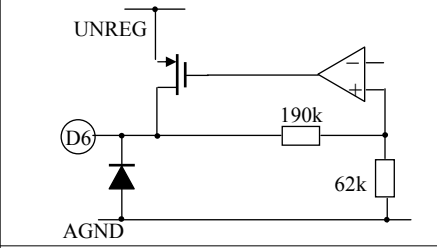
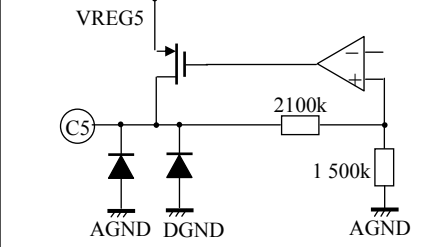
Pin No.	Waveform and Voltage	Internal Circuit	Impedance	Descriptions
E5			750 kΩ	ENA Channel-A enable input
B5			750 kΩ	ENB Channel-B enable input
D5	DC 1.236 V		—	VREF Reference voltage output
D6	DC 5 V		—	VREG5 5-V regulator output
C5	DC 3.1V		—	VREG3 3.1-V regulator output

■ Technical Data (continued)

3. I/O Block Circuit Diagrams and Pin Function Descriptions (continued)

Note) These characteristics are reference values for design, and are not guaranteed.

Pin No.	Waveform and Voltage	Internal Circuit	Impedance	Descriptions
E6	DC		—	FBA Feedback voltage input for channel-A
B6	DC		—	FBB Feedback voltage input for channel-B
A1			100 kΩ	TP2 (SI) Test circuit input
A6			100 kΩ	TP3 (SCLK) Test circuit input
F1			100 kΩ	TP1 (CS) Test circuit input
F6			—	TP4 Test circuit input

■ Technical Data
4. $P_D - T_a$ diagram

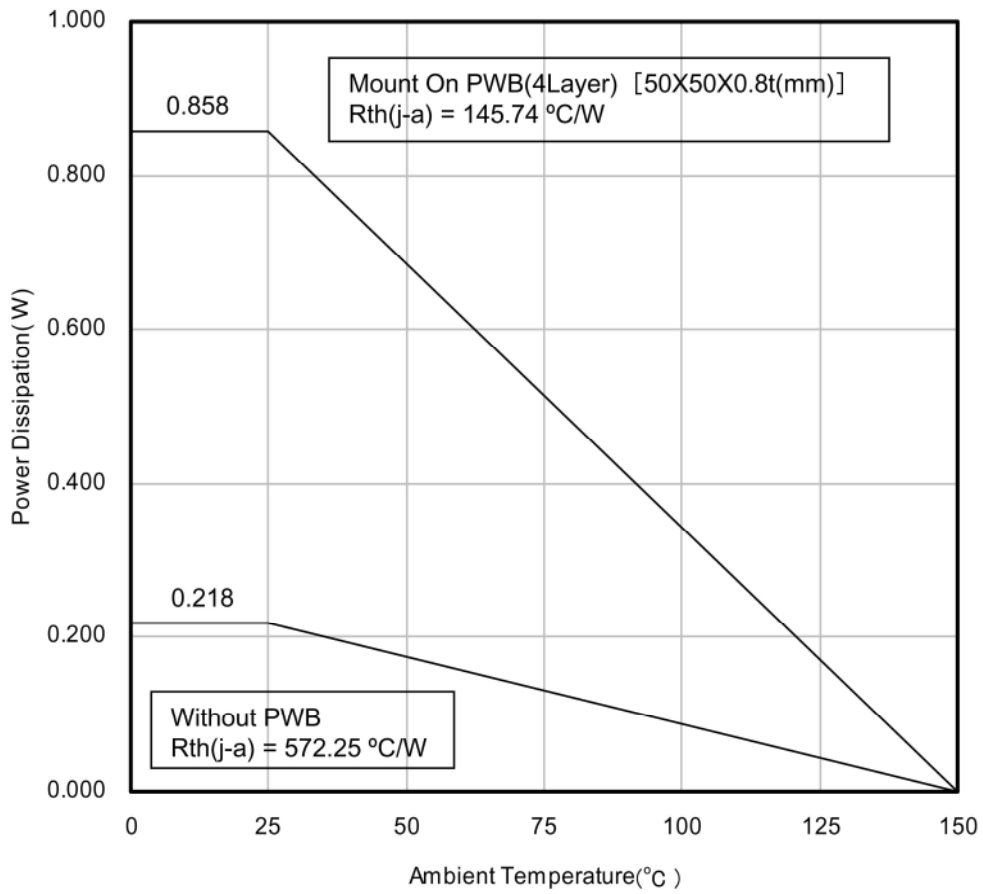

■ Usage Notes**• Special Attention and Precaution in Using the IC**

1. This IC is intended to be used for general electronic equipment [Digital still camera].
Consult our sales staff in advance for information on the following applications:
 - Special applications in which exceptional quality and reliability are required, or if the failure or malfunction of this IC may directly jeopardize life or harm the human body.
 - Any applications other than the standard applications intended.
 - (1) Space appliance (such as artificial satellite, and rocket)
 - (2) Traffic control equipment (such as for automobile, airplane, train, and ship)
 - (3) Medical equipment for life support
 - (4) Submarine transponder
 - (5) Control equipment for power plant
 - (6) Disaster prevention and security device
 - (7) Weapon
 - (8) Others: Applications requiring reliability, equivalent to that of (1) to (7).Otherwise, we will not be liable for any defect which may arise later in your equipment.
2. This IC might smoke or ignite if it is mounted in the wrong direction onto the PCB (printed circuit board). Pay attention to the direction of it.
3. Pay attention to the pattern layout of PCB in order to prevent damage due to pin-to-pin short. For pin configuration, see the Pin Descriptions.
4. Conduct a visual inspection on PCBs sufficiently prior to supplying power to the IC, to prevent damage due to pin-to-pin solder-bridge. Also, conduct a technical verification to the mounting quality sufficiently, to prevent damage due to adhering conductive foreign substance such as solder scrap during transportation.
5. Since this IC might be damaged or occasionally smoke if abnormal state occurs, such as output-VCC short (power supply fault), output-GND short (ground fault), output-to-output short (load short), or pin-to-pin leakage, care must be taken in the use of the IC. Safety measures, such as fuse installation, are recommended in order to avoid such risks.
6. When designing your equipment, comply with the range of absolute maximum ratings and the guaranteed operating conditions (operating power supply voltage and environment, etc.). Especially, please be careful not to exceed the range of absolute maximum rating on the transient state, such as power-on, power-off, and mode-switching. Otherwise, we will not be liable for any defect which may arise later in your equipment.
Even when the IC is used within the guaranteed values, take into the consideration of incidence of break down and failure mode, possible to occur to semiconductor products. Measures on the systems such as redundant design, arresting the spread of fire, or preventing glitch are recommended in order to prevent physical injury, fire, social damages, for example, by using the IC.
7. When designing your equipment with this IC, conduct safety checks including the long-term reliability for each equipment.
8. When designing application systems with this IC, read the Usage Notes described in this document thoroughly.
9. This IC has a structure that the chip is exposed to external. In case of using it in the light, functions and characteristics are not guaranteed. Please treat this IC not to be exposed to light during operation or testing process.
10. Since the chip surface is basically at ground potential, avoid the chip surface being in contact with metal shielding and others when designing your equipment.

Request for your special attention and precautions in using the technical information and semiconductors described in this book

- (1) If any of the products or technical information described in this book is to be exported or provided to non-residents, the laws and regulations of the exporting country, especially, those with regard to security export control, must be observed.
- (2) The technical information described in this book is intended only to show the main characteristics and application circuit examples of the products. No license is granted in and to any intellectual property right or other right owned by Panasonic Corporation or any other company. Therefore, no responsibility is assumed by our company as to the infringement upon any such right owned by any other company which may arise as a result of the use of technical information described in this book.
- (3) The products described in this book are intended to be used for general applications (such as office equipment, communications equipment, measuring instruments and household appliances), or for specific applications as expressly stated in this book.
Consult our sales staff in advance for information on the following applications:
 - Special applications (such as for airplanes, aerospace, automotive equipment, traffic signaling equipment, combustion equipment, life support systems and safety devices) in which exceptional quality and reliability are required, or if the failure or malfunction of the products may directly jeopardize life or harm the human body.It is to be understood that our company shall not be held responsible for any damage incurred as a result of or in connection with your using the products described in this book for any special application, unless our company agrees to your using the products in this book for any special application.
- (4) The products and product specifications described in this book are subject to change without notice for modification and/or improvement. At the final stage of your design, purchasing, or use of the products, therefore, ask for the most up-to-date Product Standards in advance to make sure that the latest specifications satisfy your requirements.
- (5) When designing your equipment, comply with the range of absolute maximum rating and the guaranteed operating conditions (operating power supply voltage and operating environment etc.). Especially, please be careful not to exceed the range of absolute maximum rating on the transient state, such as power-on, power-off and mode-switching. Otherwise, we will not be liable for any defect which may arise later in your equipment.
Even when the products are used within the guaranteed values, take into the consideration of incidence of break down and failure mode, possible to occur to semiconductor products. Measures on the systems such as redundant design, arresting the spread of fire or preventing glitch are recommended in order to prevent physical injury, fire, social damages, for example, by using the products.
- (6) Comply with the instructions for use in order to prevent breakdown and characteristics change due to external factors (ESD, EOS, thermal stress and mechanical stress) at the time of handling, mounting or at customer's process. When using products for which damp-proof packing is required, satisfy the conditions, such as shelf life and the elapsed time since first opening the packages.
- (7) This book may be not reprinted or reproduced whether wholly or partially, without the prior written permission of our company.